



# PACKAGING FOODS IN GLASS

## Introduction

This technical brief is intended to advise small-scale producers on the methods and equipment needed to package foods in glass jars and bottles. For a more detailed account of the types of foods that can be packaged in glass, the properties of glass containers, label design and production and the economic implications of introducing glass packaging the reader is advised to consult [Appropriate Food Packaging](#) by P J Fellows and B L Axtell, ILO, Published by Practical Action Publishing, 2002

## General outline of procedures

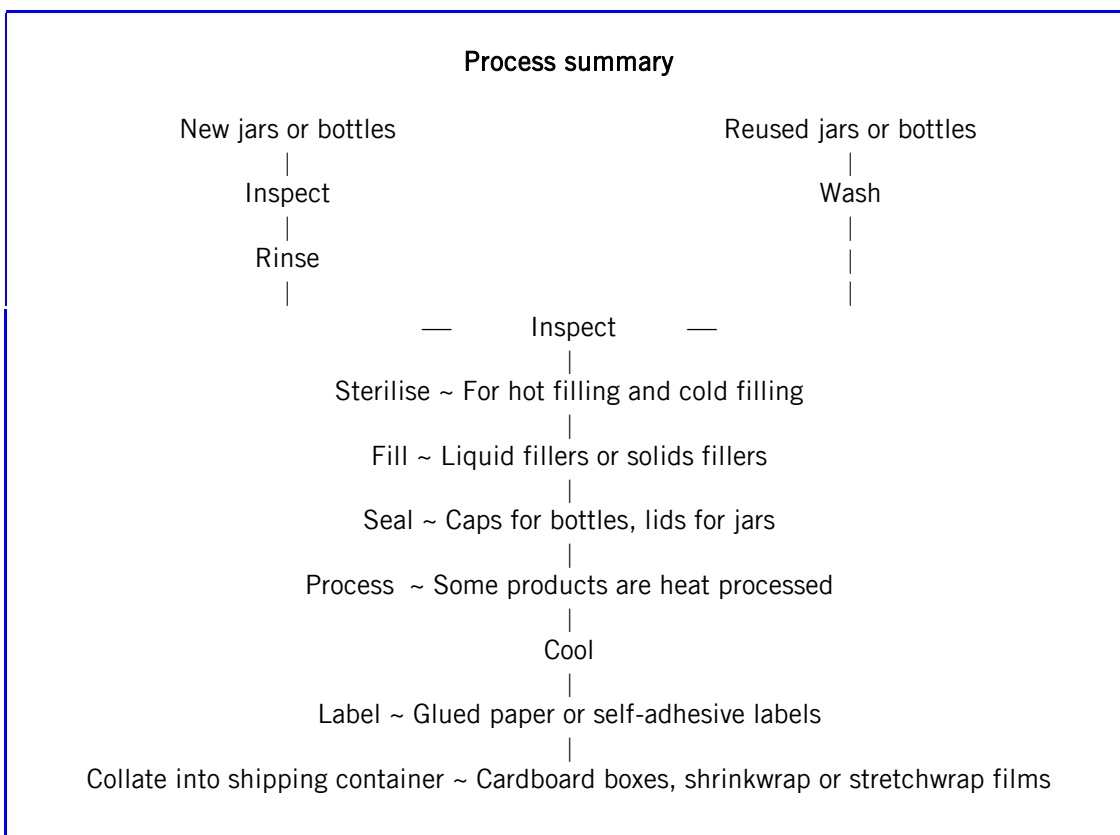

## Inspection and preparation of containers

All incoming glass containers must be inspected for cracks, chips and small bubbles in the glass. New jars and bottles should be rinsed in clean water and chlorinated if necessary by adding 2-3 drops of household bleach per litre of water.

Second hand bottles must be thoroughly inspected, both by looking for chips etc and also by smelling the containers to make sure that they have not been used for storing kerosene or poisonous chemicals (insecticides etc). All contaminated containers should be removed and not used for foods.

Second hand containers should be soaked in a 1% solution of caustic soda with detergent to remove old labels. The interior should be cleaned with a bottle brush (Figure 1) and then rinsed thoroughly. Rinsing is time consuming and can be speeded up using a bottle rinser (Figure 2).

Many foods that are packaged in glass are then heat processed and for these it is usual to hot-fill the containers (fill at 80°C or above). Glass has to be heated and cooled carefully to avoid the risk of breakage and therefore it is usual to pre-sterilise containers before hot filling. This can be done by placing bottles/jars in a large pan of warm water and heating it to boiling. The containers are boiled for 10 minutes and then removed for immediate filling and sealing.



Figure 1: Bottle brush

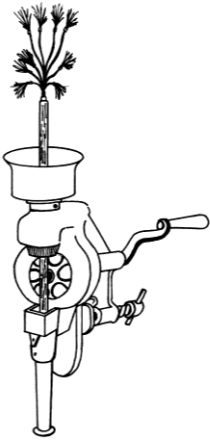

Figure 2: A bottle rinser

Alternatively a steamer (Figure 3) can be constructed and bottles/jars steamed for 1-2 minutes. This uses less energy and saves considerable amounts of time compared to using boiling water. However, care is needed to make sure that the containers are not heated too quickly, as they will break. Any weak containers will also break at this stage and bottle sterilisation should therefore be carried out away from the food production area to avoid the risk of contamination by broken glass.

Tongs as shown in Figure 3 should be used in all cases when handling hot containers.

For foods that are cold filled and then heat processed it is not necessary to pre-sterilise the container. For cold filled foods that are not subsequently heated it is essential to make sure that the jar or bottle is sterilised by one of these methods to prevent contamination of the product by any micro-organisms on the glass.

### Filling

Most foods that are packaged in glass are either liquids, such as drinks and syrups or thicker pastes such as sauces, chutneys etc.

There are basically two types of filling equipment: those used for solid foods and others for liquid foods.

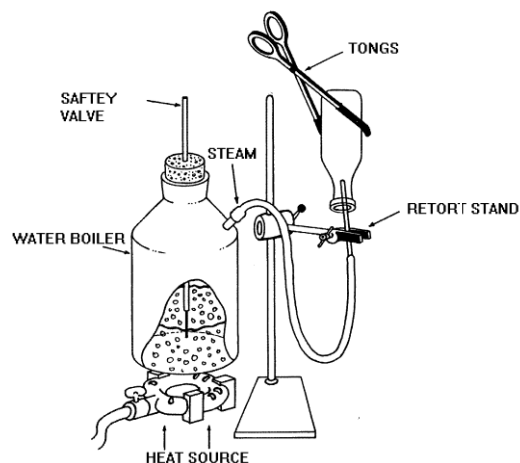

Figure 3: A steamer

**Solids fillers**

There are few paste filling machines that are cheap enough for small-scale processors but an example of one type (a piston filler) is shown in Figure 4. Most producers fill by hand and although this is slow it can be speeded up by the use of a simple funnel and rod (Figure 5).

In the case of solids such as fruit that is packed in syrup, the solid pieces are first placed in the jar by hand and the liquid is then filled using a liquids filler.

**Liquids fillers**

The simplest method is to fill containers from a jug that is calibrated for the correct volume. A funnel can be used to assist filling narrow necked bottles. A simple frame to tilt jars so that the correct filling level is achieved is shown in Figure 6, this will also speed up the filling operation.

At a larger scale of production, a filler can be made by fixing taps into a 50 litre stainless steel bucket (Figure 7). Food grade plastic is acceptable for cold filling.

However, these methods are relatively slow and therefore only suitable for small production rates (eg up to 1000 packs per day). They also give some variation in the filled volume, even with careful training of the operators.

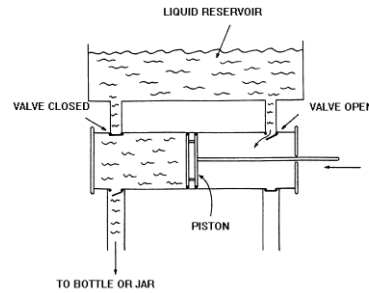

Figure 4: A piston filler



Figure 5: Funnel and rod

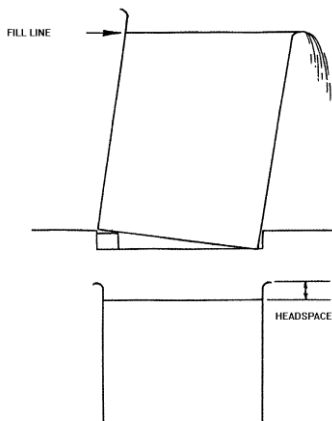

Figure 6: Simple frame and jar filling

At higher production rates a piston filler gives a uniform fill-volume and can be adjusted to fill different containers from 25-800 ml. Typical outputs are 15-30 packs per minute.

A different approach is to use a vacuum filler. These are available commercially but can also be made locally. The principle of operation is shown in Figure 8. A venturi pump, obtained from a laboratory supplier, is attached to a water tap to create the vacuum. This then sucks liquid from a product tank into the bottle until it fills to a pre-set level.

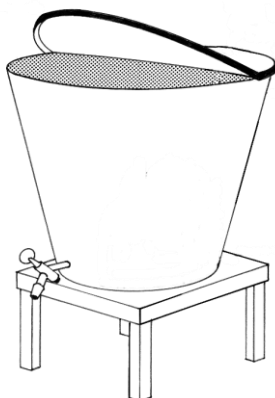

Figure 7: Bucket with tap

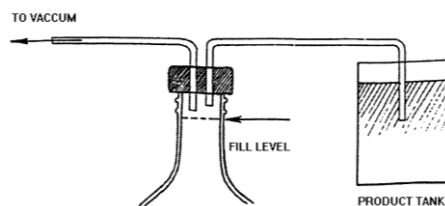

Figure 8: Vacuum filler

technical brief

## Sealing

Most caps for bottles and jars have a ring of plastic material (sometimes waxed card or cork) which forms a tight seal against the glass. During hot filling and heat processing this plastic softens and beds itself around the glass to make an hermetic seal. However, before this happens there is a risk that small amounts of air can be sucked into a container and cause contamination of the product. The risk of contamination can be reduced by laying a filled container on its side for about 10 minutes to ensure that the seal is perfectly formed.

Specific types of equipment are used for sealing the different caps that are used for glass containers.

For bottles the main types are:

- crown caps
- roll-on-pilfer-proof (ROPP) caps
- snap-on caps
- corks

For jars the main types are:

- twist-on-twist-off (TOTO) lids
- push on lids

All lids and caps should neither affect the product nor be affected by it and they should seal the container for its expected shelf life. This is usually found by testing trial containers with the product to be packaged to make sure that there is no interaction between the pack and the product. Expert advice should also be sought from the packaging suppliers when selecting the type of closure to be used.

## Bottles

Crown caps are commonly used for beer bottles and fruit juices. Hand-operated equipment is available in a number of sizes from a simple former that is placed over the cap and hit with a mallet, to the hand-held lever type shown in Figure 9 and table mounted model shown in Figure 10.

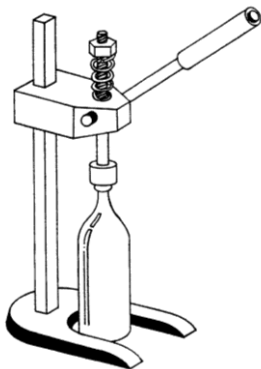

Figure 9: Hand held bottle capping

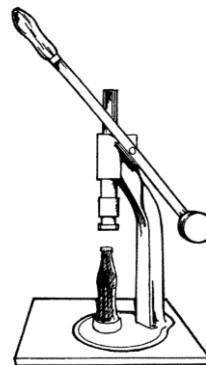

Figure 10: Table mounted bottle capping

Roll-on-pilfer-proof (ROPP) caps are fitted by placing a blank cap on the bottle and then pressing the metal into the screw thread of the glass. Finally, a ring of perforated metal is formed at the base of the cap that shows evidence of tampering or pilfering. Hand operated ROPP machines can be constructed locally (Figure 11) and small motorised version are available commercially (Figure 12). A simpler cap which does not incorporate the pilferproof feature is known as a 'Roll-on (RO) cap and this can be fitted by similar types of equipment.

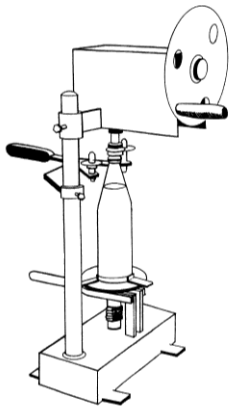

Figure 11: Hand operated ROPP machine

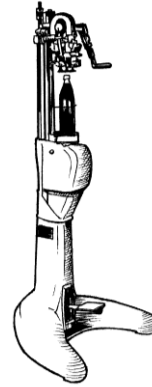

Figure 12: Motorised ROPP machine

Plastic snap-on caps are fitted over the neck of the bottle and sealed by a capping machine (Figure 13).

Corks are mostly used to seal wine bottles and hand operated corkers which both squeeze the cork and insert it into the bottle are available (Figure 14). Corks are first wetted to make them slip more easily into the bottle and they then expand to give an airtight, waterproof seal. As corks may be contaminated by microorganisms, it is important that the soaking water contains either a few drops of bleach per litre or sodium metabisulphite at approximately one teaspoonful per 5 litres.

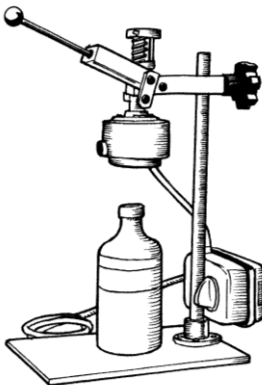

Figure 13: Capping machine

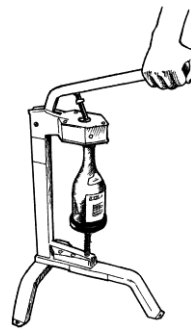

Figure 14: Hand operated corking machine

### Jars

Push-on lids are still used for sealing jars (Figure 15) although these are increasingly being replaced by twist-on-twist-off (TOTO) lids. Small equipment is available for each of these types of closure.

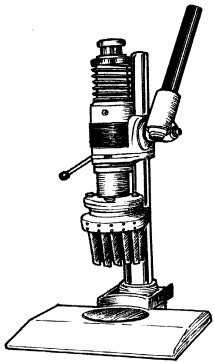

Figure 15: Jar sealer

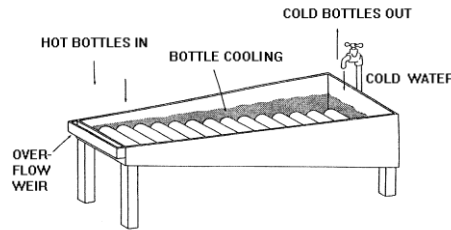

Figure 16: Bottle cooling equipment

**Processing**

Some products are heat processed after packing into glass containers. They should be heated and cooled gently in order to avoid breaking the glass. One method of controlled cooling of containers after processing is shown in Figure (16). Cold water enters at the deep end of the trough and overflows at the shallow end. Hot bottles are placed in at the shallow end and roll down to the deep end. The temperature is cool at the deep end and gets hotter along the trough, so minimising the shock to the hot containers.

**Labelling**

Paper labels are the most common type used on glass containers. They can be plain paper that is glued onto the glass or alternatively self-adhesive types. Figure 17 shows a simple frame which can be used to hold plain labels, wipe glue over top of label in stack, roll jar along guide rail over label, roll and press jar and label into rubber mat. Small labelling machines (Figure 18) can be used to apply strips of glue to labels. A typical powered labeller has an output of about 40 labels per minute.

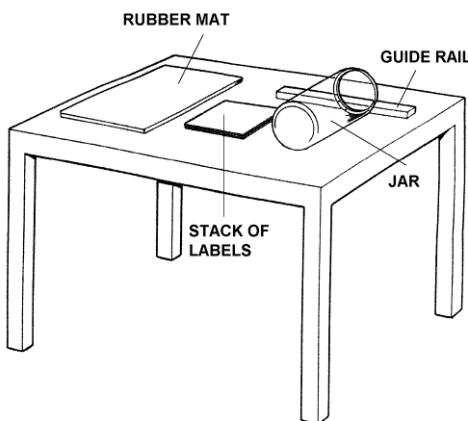

Figure 17: Labelling table

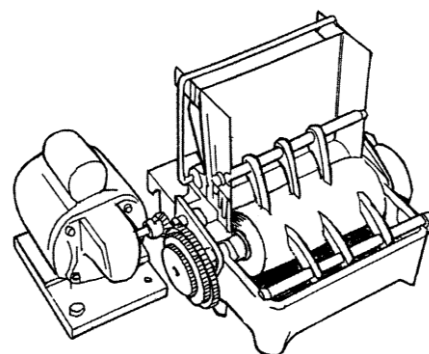

Figure 18: Small labelling machine

Water soluble glues such as starch or cellulose based glues are best if containers are returnable, so that labels can be easily removed. However, these glues may loose adhesion in humid climates. Non water-soluble glues, based on plastic polymers, are available and advice on the correct type should be sought from the suppliers.

technical brief

Self-adhesive labels can be bought, fixed to a backing (or 'release') paper in rolls or sheets. They can be applied by hand, by small hand held machines or by powered labellers. The type shown in Figure 19 can apply 30-40 labels per minute.

### Quality control

This should be seen as a method of saving money and ensuring good quality products and not as an unnecessary expense. The time and effort put into quality control should therefore be related to the types of problems experienced or expected. For example, glass splinters in a food are very serious and every effort should be made to prevent them, whereas a misaligned label may not look attractive but will not harm the customers.

Faults can be classified as:

### Critical

likely to harm the customer or operator or make the food unsafe (eg glass splinters)

### Major

likely to make the package unsuitable for use in the process or result in a serious loss of money to the business (eg non-vertical bottles that would break in a filling machine)

### Minor

likely to affect the appearance of a pack (eg ink smudges on the label)

Critical faults should always be checked for, whereas others may be examined, if they are causing problems.

For glass containers the critical faults are broken, cracked, or chipped glass, strands of glass stretched across the inside of new packs, or bubbles in the glass that make it very thin in places. Major faults are variations in the size and shape of containers and minor faults include uneven surfaces, off colours in the glass, rough mould lines and faults with the label.

One further quality control measure that is important with glass containers is to check variations in the weight of jars and bottles as these variations will affect the fill-weight. Random samples should be taken from the delivery of containers (eg 1 in 50 containers) and weighed. The heaviest pack should then be used to calculate the final filled weight required.

Quality control needs trained staff, an established procedure and some equipment and facilities. Staff are the most important and all operators should be trained to look out for faults in the product or package. One staff member should have responsibility for checking the packaging.

All glass jars and bottles should be checked for critical faults and if second-hand, checked for contamination before washing. Other quality control checks include:

- the filled weight (to ensure that the net weight is the same as that declared on the label)
- the appearance of the pack
- a proper seal formed by the cap
- the presence and position of the correct label.

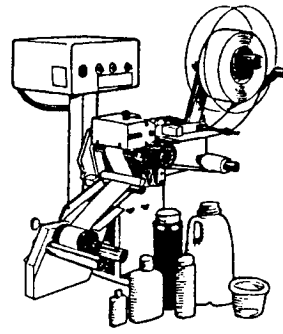

Figure 19: Powered labelling machine

Filled weight can be checked using a scale that has the package plus a known weight on one side and samples of filled product placed on the other side (Figure 20). The number of samples required to be checked depends on the amount of food produced and the method of filling. In general hand filling is more variable than machines and therefore more samples are required. As a rough guide, one in every twenty packs should be checked.

#### Collation for transport/distribution

Once the containers have been filled, sealed and labelled they are grouped together to make transport and handling easier. Cardboard boxes are most commonly used and these can be bought or made up on site. A paper label can be used to cover existing printing on reused boxes and also advertise the product during distribution.

The required size of a box can be found by placing together the containers to be packed, together with dividers, and measuring the size to find the minimum internal dimensions (see Figure 21).

Newer methods of collating containers include shrinkwrap or stretchwrap films which hold the bottles or jars together on card trays (Figures 22 & 23).

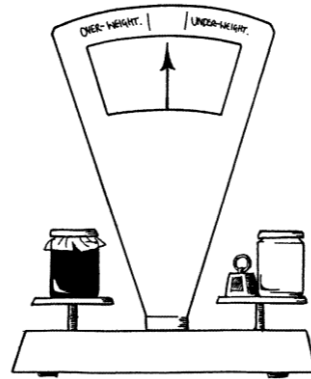

Figure 20: Scales

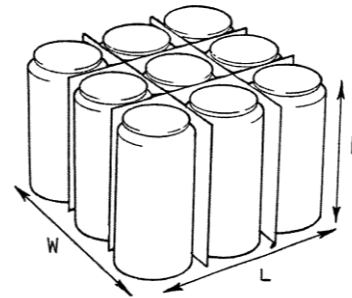

Figure 21: Sizing

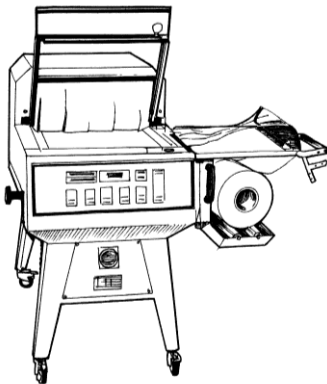

Figure 22: Wrapping machine

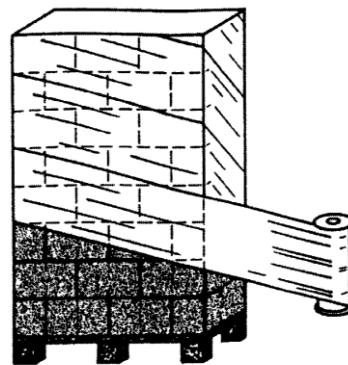

Figure 23 Wrapping boxes for transport



## Equipment suppliers

### Bottle/cap sealers

Rajan Universal Exports (MFRS) P Limited  
Raj Buildings 162  
Linghi  
Chetty Street  
P Bag No 250  
Madras 600 001  
India  
Tel: +91 (0)44 2534 1711  
Fax: +91 (0)44 2534 2323

Narangs Corporation  
25/90 Connaught Place  
Below Madras Hotel  
New Delhi 110 001  
India  
Tel: +91 (0)11 2336 3547  
Fax:+91 (0)11 2374 6705

M.M.M.Buxabhoy & Co. 140 Sarang Street  
1st.Floor  
Near Crawford Market  
Mumbai  
India  
Telephone: +91 (0)22 2344 2902  
Fax: +91 (0)22 2345 2532  
Email: [yusufs@glasbm01.vsnl.net.in](mailto:yusufs@glasbm01.vsnl.net.in)  
Manual heat sealing machine used for sealing  
plugs of plastic containers, bottles, jars  
and jerry cans.

technical brief

## Liquid Filling Equipment

Geeta Food Engineering Plot No. C-7/1 TTC Area  
Pawana MIDC  
Thane Belapur Road  
Behind Savita Chemicals Ltd.  
Navi Mumbai - 400 705  
India  
Tel: +91 (0)22 2782 6626/766 2098  
Fax: +91 (0)22 2782 6337  
Bottle Washing and Filling Machine

Autopack Machines PVT LTD 101-C, Poonam Chambers  
'A' Wing, 1st Floor  
Dr. Annie Besant Road  
Worli  
Mumbai - 400 018  
India  
Tel: +91 (0)22 2493 4406/2497 4800/2492 4806  
Fax: +91 (0)22 2496 4926  
E-mail: [autopack@bom3.vsnl.net.in](mailto:autopack@bom3.vsnl.net.in)  
Pneumatic liquid filler suitable for filling any food products in liquid form into bottles. No electric power is required. Up to 20 fills/minute

## Bottle washing Equipment

Gardners Corporation 6 Doctors Lane  
Near Gole Market  
PO Box 299  
New Delhi - 110001  
India  
Tel: +91 (0)11 2334 4287 / 336 3640  
Fax: +91 (0)11 2371 7179  
Bottle Washing Machine. This machine has 2 brushes and a drive motor.  
Power: Electric.

## Labelling machines

Rank and Company A-95/3  
Wazirpur Industrial Estate  
Delhi - 110 052  
India  
Tel: +91 (0)11 2745 6101/2/3/4  
Fax: +91 (0)11 2723 4126 / 2743 3905  
Email: [rank@poboxes.com](mailto:rank@poboxes.com)  
Label Gumming Machine Used for pasting gum on labels.

Dairy Udyog C-230, Ghatkopar Industrial Estate  
L.B.S. Marg  
Ghatkopar (West)  
Bombay - 400 086  
India  
Tel: +91 (0)22 2517 1636 / 517 1960  
Fax: +91 (0)22 2517 0878  
Email: [jipun@vsnl.com](mailto:jipun@vsnl.com)  
Sealing and Filling Machines: Semi automatic machine for packing liquids such as milk, oil, ghee etc. in pillow packs.  
Capacity: 300 pack/hour Power: Electric

Mark Industries PVT Ltd 348/1 Dilu Road  
Mokbazar  
Dhaka-1000  
Bangladesh  
Tel: +880 2 9331778 / 835629 / 835578  
Fax: +880 2 841049  
E-mail: [markind@citechco.net](mailto:markind@citechco.net)  
Manually powered Juice filling machine.

Dairy Udyog  
Ghatkopar Industrial Estate  
LBS Marge, Ghatkopar,  
Mumbai 400 086, India  
Tel: +91 (0)22 2517 1636/ 2517 1960  
Fax: +91 (0)22 2517 0878  
Bottle brushes

Narangs Corporation  
25/90 Connaught Place  
Below Madras Hotel  
New Delhi 110 001  
India  
Tel: 91 (0)11 2336 3547  
Fax: 91 (0)11 2374 6705  
Labelling Gumming Machines This hand operated label gumming machine is suitable for labels of up to 15cm width. Power: Manual

Bhavani Sales Corporation Plot No.2/1  
 Phase II  
 GIDC  
 Vatva  
 Ahmedabad - 382 445  
 India  
 Tel: +91 (0) 79 2583 1346 / 2589 3253  
 Fax: +91 (0)79 2583 5885 / 2583 1346  
 Email: [labeling@ad1.vsnl.net.in](mailto:labeling@ad1.vsnl.net.in)  
 Semi automatic labelling machine suitable  
 for all types of round containers, jars, tins,  
 cans and bottles. Capacity: 30-40  
 containers/minute

*Crown Capping Machine* Engineering Drawings Practical Action  
 The design is of a manually operated crown capping machine similar to the one in figure 9  
*Roll on Pilfer Proof Machine* Engineering Drawings Practical Action  
 The design is of a manually operated ROPP machine similar to the one in figure 11.

## References and further information

[Food Packaging](#) a selection of Practical Action Technical Briefs  
[Appropriate Food Packaging](#) by Peter Fellows & Barry Axtell, Practical Action Publishing  
 ILO/TOOL 1993  
[Packaging](#) UNIFEM Practical Action Publishing 1996  
[Small-scale Food Processing: A guide to appropriate equipment](#), Edited by Peter Fellows & Ann  
 Hampton, Practical Action Publishing/CTA 1992  
[Small-scale Food Processing: A Directory of Equipment and Methods](#) by Sue Azam-Ali  
 Practical Action Publishing, 2003

### Acknowledgements

Diagrams and text used in this technical brief come from a variety of sources. We would therefore like to thank the following for allowing us to reproduce: Practical Action Publishing, ILO, and PRODEC.

Practical Action  
 The Schumacher Centre  
 Bourton-on-Dunsmore  
 Rugby, Warwickshire, CV23 9QZ  
 United Kingdom  
 Tel: +44 (0)1926 634400  
 Fax: +44 (0)1926 634401  
 E-mail: [inforsew@practicalaction.org.uk](mailto:inforsew@practicalaction.org.uk)  
 Website: <http://practicalaction.org/practicalanswers/>

Practical Action is a development charity with a difference. We know the simplest ideas can have the most profound, life-changing effect on poor people across the world. For over 40 years, we have been working closely with some of the world's poorest people - using simple technology to fight poverty and transform their lives for the better. We currently work in 15 countries in Africa, South Asia and Latin America.